

The General Radio Experimenter

VOL. IV, No. 5

OCTOBER, 1929

A LOW-FREQUENCY OSCILLATOR

By L. B. ARGUIMBAU

RECENTLY the increased attention paid to the operation of broadcast circuits at the lowest audible frequencies has created a demand for measuring equipment to cover this range. With this in view the General Radio Company has extended the frequency range of its TYPE 377 Low-Frequency Oscillator to include all frequencies lying between 25 cycles and 70,000 cycles.

At the same time that this change was contemplated it was thought desirable to design the new oscillator for use with one particular type of tube to operate under fixed battery conditions. In the TYPE 377 Low-Frequency Oscillator the choice of tubes and their operating points was left to the user for the added flexibility thereby obtained. In many cases, however, the general recommendations given were not followed; high-power tubes were used with incorrect operating conditions, and the oscillator was seriously overloaded with resultant distortion. It was believed that this situation could best be avoided by settling on definite operating conditions, providing an instrument with the power level best adapted to the average user, and employing additional amplification if needed in special cases.

Before going into a discussion of the characteristics of the new TYPE 377-B Low-Frequency Oscillator, it may be of interest to outline briefly the theory of its operation so that the necessity for certain adjustments may be better appreciated.

Consider the amplifier circuit shown in Figure 1. In accordance with the usual tube theory, a small sinusoidal voltage e_g applied to the grid will be amplified in the customary way, giving rise to a slightly distorted plate-current wave. Most of the higher harmonics are filtered out in the tuned circuit so that the voltage e_s across the transformer secondary will be essentially sinusoidal. If the resistance R is properly chosen, this secondary voltage can be made exactly equal to the applied grid voltage. When this has been done, we may connect the circuit as shown in Figure 2, and oscillations will be sustained. The departure of the grid voltage from a sine wave depends upon the magnitude of the swing and operating point and also upon the selectivity of the tuned circuit. Just as in the usual amplifier theory, the least distortion will be present when the grid-voltage-plate-current characteristic of the tube is essentially straight.

[1]



IET LABS, INC in the GenRad tradition
534 Main Street, Westbury, NY 11590

www.ietlabs.com
TEL: (516) 334-9559 • (800) 899-8438 • FAX: (516) 334-5988

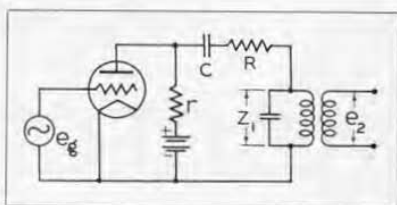

FIGURE 1. Vacuum-tube amplifier with input voltage e_g and output voltage e_o

It has been found that the grid current in an oscillator tube provides a remarkably simple and accurate means for estimating the amplitude of oscillation. For a given grid current, we can say that the grid swing has a definite value, regardless of the characteristic of the coil and the frequency chosen. Hence, if R is adjusted to give a predetermined grid current, the grid will be operating at a given swing, a consideration of prime importance when the signal is to supply an amplifier tube.

For those who may be interested, a brief sketch of the details is given in Appendix A. The important point to be noticed is the close analogy between an oscillator of this type and a tuned amplifier. Further application of this analogy can be made to account exactly for the waveform obtained and for the variation of frequency with operating point, but this is too involved to be of interest.

The circuit finally adopted for the TYPE 377-B Low-Frequency Oscillator is shown schematically in Figure 5 where it will be noticed that this follows the outline given above. An adjustable 100,000-ohm rheostat R is used as a feed-back resistance and it should be adjusted to give a grid current of 30 micro-amperes (as indicated on a 0-200 micro-ampere meter mounted on the panel). The 50,000-ohm plate-supply resistance r provides a good coupling device and at the same time limits the oscillator plate

current to about 2 milliamperes. In Figure 3 a tuned-plate oscillator is shown. In practice it was found desirable to use a Hartley circuit for the lower end of the range, using the tuned-plate circuit at higher frequencies.

It will be noticed that the output power is taken off across a slide-wire potentiometer in the plate circuit of the last tube. This was done for two reasons: to prevent interaction with the oscillator tube and to prevent the waveform from varying excessively with the output setting. It should be noticed that this arrangement makes the effective output impedance of the oscillator depend upon the potentiometer setting. In a few isolated cases (such as measurements on harmonic production in non-linear circuits) this is undesirable, but for all ordinary purposes it causes no difficulty. Measurements on harmonic production and

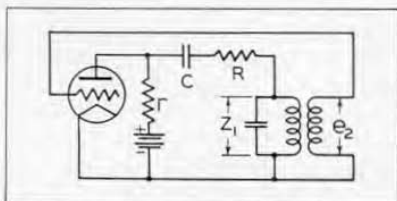
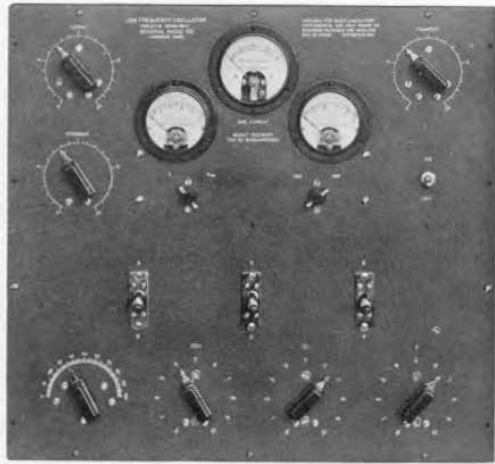

FIGURE 2. The amplifier of Figure 1 becomes an oscillator when its input voltage is supplied by the output circuit

allied phenomena require special precautions, and no ordinary coupling device should be used without a careful consideration of its effect on the circuit being studied. In all measurements on linear circuits where the effect of harmonic flow is of no interest, the impedance of the generator tube need not be considered; by proper connections, any source impedance from zero to an arbitrarily large value can be simulated. This matter is treated at length in the November issue of the *Experimenter*.

FIGURE 3. Front of panel view of TYPE 377-B Low-Frequency Oscillator. It is mounted in a heavy hinged-back cabinet



Recognizing that the needs of different users will vary somewhat, provision has been made for using either one or two amplifier tubes. If only a small amount of power is needed and it is desired to reduce battery drain to a minimum, only one tube need be used; the total plate current will then be about 10 milliamperes. Without any change in the circuit, a second tube may be added in parallel; in this case, the plate current will then be about 16 milliamperes. Typical output

characteristics for these two cases are shown in Figure 6.

A series of measurements has been made with a harmonic analyzer to determine the dependence of waveform on operating conditions. These measurements show that the voltage wave given by the oscillator tube itself contains no harmonic having an amplitude larger than 0.5 per cent. of the fundamental. On the other hand, the amplifier has been designed to deliver the maximum amount of power con-

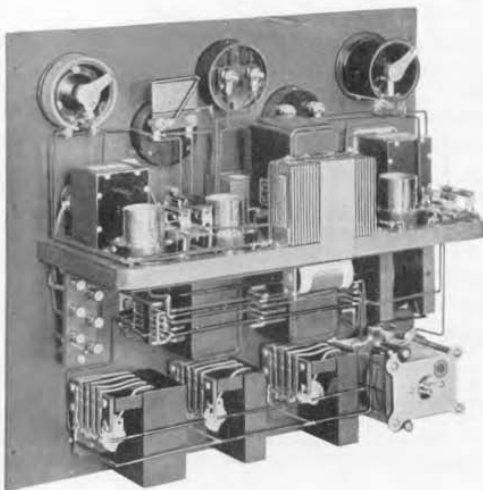

FIGURE 4. This photograph shows the internal construction of the TYPE 377-B Low-Frequency Oscillator

sistent with the usual requirements on waveform. Harmonics introduced by the amplifier may amount to 3 per cent. of the fundamental. If much better waveform is required, it is necessary to reduce the signal level at which the last stage is operating. This may be accomplished by substituting a 1.0 megohm resistance for the 0.5 megohm unit in the place marked A in Figure 5. This change reduces the harmonics to 1.0 per cent. of the fundamental, if the load resistance is not less than 8000 ohms.

The adjustment of the feed-back resistance for constant grid current helps to minimize the changes in frequency due to operating condition. Measurements on one particular oscillator showed that for frequencies in the neighborhood of 40 cycles, changes in plate battery amounting to 25 per cent. made a change in frequency of less than 0.1 per cent. when the feed-back was readjusted to give 30 micro-amperes. If no adjustment was made, the departure was less than 0.3 per cent. If the grid current was allowed to depart by 10 micro-amperes from the rated value, the frequency drift was not more than 0.3 per cent. Changing the oscillator tube gave rise

to similar differences. At 25 cycles the changes were about twice as large as those mentioned (i.e., a maximum of about one-tenth of a cycle).

These figures refer to frequency changes covered by tubes and operating points. Ageing effects may be larger but they should never exceed 3 per cent.

APPENDIX A

Consider the amplifier circuit shown in Figure 1. Assume a sinusoidal voltage e_g impressed on the grid. When this swing is very small, we may treat the circuit in accordance with the usual tube theory, considering the tube as a sinusoidal generator μe_g in series with a resistance r_p , the internal plate impedance of the tube. Neglecting the effect of the shunt resistance r and the condenser C^* we may write for

* By the use of Thévenin's Theorem we may eliminate the effect of the parallel resistance r and the condenser C by making the substitutions,

$$\mu' = \left(\frac{1}{1 + \frac{r_p}{r}} \right) \mu \text{ and } r_p' = \left(\frac{1}{1 + \frac{r_p}{r}} \right) r_p - j \frac{1}{\omega C},$$

using these new quantities in place of μ and r_p . It will be noticed that this has little effect when

$$r_p \ll r \text{ and } \frac{1}{\omega C} \ll r.$$

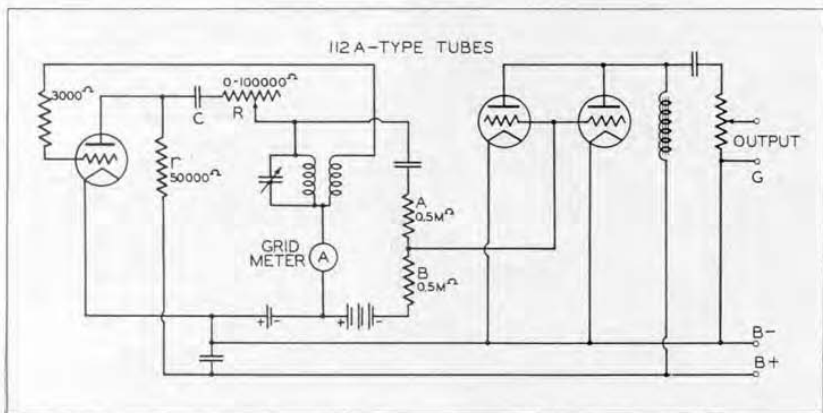

FIGURE 5. Functional schematic diagram for the TYPE 377-B Low-Frequency Oscillator

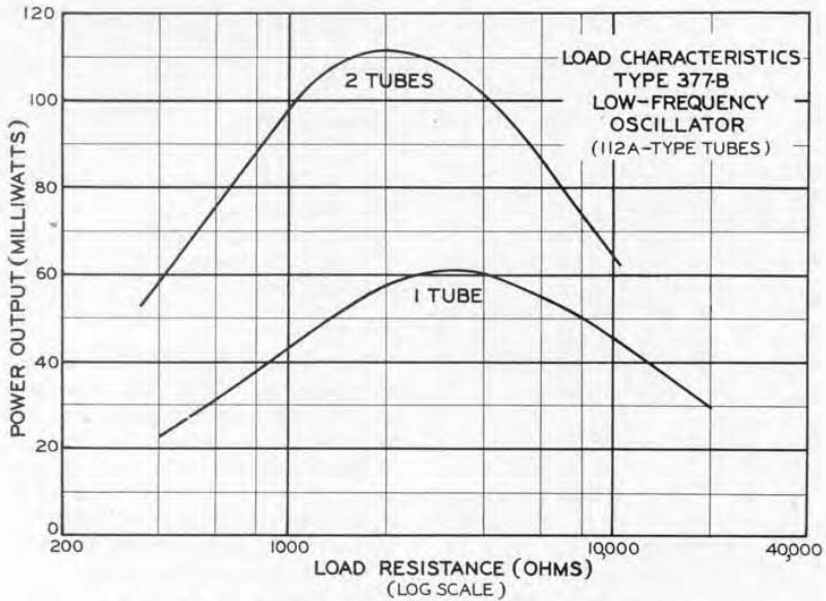

FIGURE 6. Power output of the oscillator as a function of load resistance

the magnitude of the voltage across the secondary,

$$e_2 = \frac{n_2}{n_1} \cdot \frac{Z_1}{r_p + R + Z_1} \cdot \mu e_g \quad (1)$$

Z_1 is the impedance of the parallel circuit, and $\frac{n_2}{n_1}$ is the turns ratio of the transformer. Even though some distortion is produced by variations in plate resistance introducing harmonics in the plate current, the voltage across the tuned circuit Z_1 will be very nearly sinusoidal. (Actually, the harmonics at this point can be kept below 0.5 per cent.) It is to be noted that for a given tuned circuit and tubes (i.e., given Z_1 and r_p), the secondary voltage can be regarded as a function of the coupling resistance R . In particular, if Z_1 is sufficiently high we can choose R in such a manner that the secondary voltage e_2 is equal to the applied grid voltage e_g . When this has been done we may rewrite (1):

$$r_p + R = \left(\mu \frac{n_2}{n_1} - 1 \right) Z_1.$$

Actually, of course, this is not the whole story. In practice the amplitude will adjust itself until the dynamic impedance satisfies the above equation. By properly choosing R , however, we can select any such equilibrium position, thereby fixing the amplitude. The flow of harmonics out-of-phase with the fundamental will introduce a reactive component in the plate impedance and cause the frequency to assume such a value as to give an equal and opposite phase shift in the tuned circuit. This phase shift will be obtained in the case of a sharply resonant circuit by a much smaller percentage change in frequency than is the case in a broadly tuned circuit.

The commercial data for the TYPE 337-B Low-Frequency Oscillator are the same as for the old design. Price, also, remains unchanged.

NOTES ON POWER MEASUREMENT IN COMMUNICATION CIRCUITS

By JOHN D. CRAWFORD

DETERMINING the transmission characteristics of communications apparatus is, like all other problems in measurement, nothing more than the judicious application of certain standardized definitions. A possible difference may be claimed in the fact that these quantities are defined, for convenience, as the logarithm of a ratio where almost every one else would be content to talk about the simple arithmetical ratio. But to claim special privilege on that score would be a most puerile form of quibbling.

This kind of measurement is, after all, the straightforward application of engineering principles. It has a technique and a system of definition that are peculiar to itself, but so has every specialized business. Yet, when for the first time one is confronted with the practical aspects of finding out how the amount of power obtainable from a system is affected by changes in the circuit conditions, there is, seemingly, an instinctive tendency toward confusion.

The principal difficulties appear because standardized definitions have not been readily available. One has had to rely on piecemeal information, and it is little wonder that there should be confusion when one finds himself unable to uncover satisfactory definitions and criticize methods.

We have, therefore, prepared these notes for the purpose of discussing some of the difficulties. The first section shows that an error may be involved in blindly assuming that voltage or current ratios may be substituted for power ratios when measuring attenuation, gain, transmission

loss, etc. The second section describes two commonly-used methods for making *any* generator or oscillator simulate a source of power having any impedance characteristic.

I

The definitions for transmission measurements such as various kinds of gain, attenuation, and losses have one thing in common: they all express, in logarithmic form, the ratio between two amounts of power. When and under what condition the powers are measured is a matter of definition with which we shall not now concern ourselves because we wish to emphasize the generality of the following remarks.

First, consider the equation defining the decibel in terms of the power ratio, understanding, meanwhile, that our emphasis upon *power ratio* is necessary because the measured quantities deal with power, not because one unit has been arbitrarily defined that way. We say that any two amounts of power — W_1 and W_2 in Figure 1, for example — differ by N decibels where

$$N = 10 \log_{10} \frac{W_1}{W_2} \quad (1)$$

Now the equations linking the voltage, current, and power in a power-absorbing circuit are:

$$W = \frac{E^2 k}{Z} \quad \text{and} \quad W = I^2 Z k = I^2 R, \quad (2)$$

where W = absorbed power

E = voltage drop

Z = impedance

k = power factor

I = current

R = effective resistance.

[6]



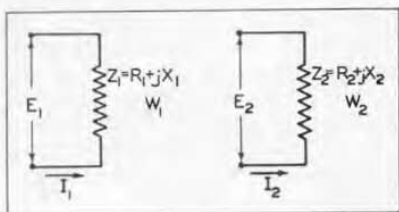

FIGURE 1

Applying (2) to (1) we find (a) that using currents,

$$N = 10 \log_{10} \frac{I_1^2 R_1}{I_2^2 R_2}$$

$$= 20 \log_{10} \frac{I_1}{I_2} + 10 \log_{10} \frac{R_1}{R_2}, \quad (3a)$$

and that (b) using voltages,

$$N = 10 \log_{10} \frac{E_1^2 Z_2 k_1}{E_2^2 Z_1 k_2} = 20 \log_{10} \frac{E_1}{E_2}$$

$$+ 10 \log_{10} \frac{Z_2}{Z_1} + 10 \log_{10} \frac{k_1}{k_2}. \quad (3b)$$

This may be summarized in the following simple statement: When measuring ratios between currents and between voltages for expressing these transmission characteristics, both the nature and the magnitude of the impedances must be taken into account.

In other words, if you measure the currents, you must know the effective resistances; if you measure the voltages, you must know both the effective resistances and the reactances of the circuits with which you are working. If the current or voltage ratios are measured without taking into account the impedance conditions, current ratio measurements will produce an error of $10 \log_{10} \frac{R_1}{R_2}$ decibels, and voltage ratio measurements will yield an error of $10 \log_{10} \frac{Z_2}{Z_1} + 10 \log_{10} \frac{k_1}{k_2}$ decibels. In this connection it is worth noting that the impedance relations to be satisfied are not necessarily the same

as those implied by the phrases "equal impedances" or "matched impedances" when specifying the conditions for maximum energy transfer or for the elimination of reflection losses.

In order to anticipate protests from readers who can, in effect, quote Scripture to prove that the quantities we have been discussing are based upon voltage or current ratios, allow us to make the following remarks:

In recognized text books the use of voltage and current ratios is an alternative to the use of the power ratio, and the impedance conditions are implied even if they are not stated in so many words. Most of the classical theory of transmission lines and networks is built up and taught on the long-line basis; that is to say that a transmission line, infinite in length and with uniformly distributed constants, is broken up into sections and the behavior of each section studied. The impedance at any junction between recurrent sections looking down the line toward the receiving end is the same as the impedance looking into the same section at the preceding junction. Since the impedances are the same, the current ratios and the voltage ratios are equivalent to the power ratio. Because this ratio of input to output power happens to be the power ratio of greatest interest, it is natural that the voltage and current ratios should be substituted. Here, the impedance conditions are *implied*.

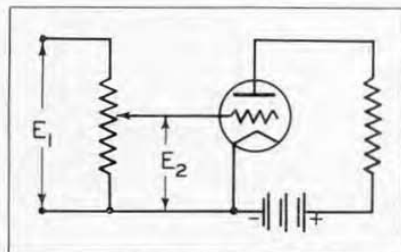

FIGURE 2

Another instance where the impedance conditions are implied is that where one of the loads is the high-impedance input circuit of a vacuum tube. Since the vacuum tube is, to a first approximation at least, a voltage-operated device, the power it absorbs bears no particular relation to the power it delivers. If, however, the power in the output circuit of the tube is measured and compared with the power delivered to the same circuit

with a different applied voltage, the power ratio will have its true significance. Presumably the power in the output circuit of the tube is proportional to the square of the grid voltage and under these conditions, it is perfectly proper to use the voltage ratios (see Figure 2).

The second part of "Notes on Power Measurement in Communication Circuits" will appear in the November issue of the Experimenter.

MISCELLANY

By THE EDITOR

THE General Radio Company takes pleasure in welcoming Robert F. Field, who joined its staff on October 1. Mr. Field received his A.B. from Brown University in 1906 and his A.M. the following year. He taught physics and electrical engineering there until 1915, leaving to take work at Harvard University, where he was awarded an A.M. in 1916. From 1918 until the present, he has been teaching at the Cruft Laboratory which offers courses common to both the Engineering School and the Department of Physics at Harvard University. As Assistant Professor of Applied Physics, he taught courses in communi-

cation engineering, specializing in electrical measurements.

With the General Radio Company, Mr. Field will undertake development work on bridges and fundamental standards of resistance, inductance and capacitance, particularly at high frequencies. He will also study the applications of electrical measurements to bio-physical problems.

CONTRIBUTORS

Both contributors to this issue of the General Radio *Experimenter* are members of the General Radio Company's Engineering Department.

The General Radio *Experimenter* is published monthly to furnish useful information about the radio and electrical laboratory apparatus manufactured by the General Radio Company. It is sent without charge to interested persons. Requests should be addressed to the

GENERAL RADIO COMPANY
CAMBRIDGE A, MASSACHUSETTS

RUMFORD PRESS
CONCORD



IET LABS, INC in the GenRad tradition
534 Main Street, Westbury, NY 11590

www.ietlabs.com
TEL: (516) 334-5959 • (800) 899-8438 • FAX: (516) 334-5988