

THE *General Radio* EXPERIMENTER

VOLUME XXIV No. 4

SEPTEMBER, 1949

Copyright, 1949, General Radio Company, Cambridge, Mass., U. S. A.

ELECTRICAL MEASUREMENTS AND THEIR INDUSTRIAL APPLICATIONS

GENERAL-PURPOSE A-M STANDARD-SIGNAL GENERATOR

● A NEW general-purpose A-M standard-signal generator is now in production, superseding the TYPE 605, which was discontinued some time ago. The new generator, TYPE 1001-A, embodies a number of features of design and construction that result in performance characteristics that are greatly improved over those of its predecessor. Among the specific improvements are higher output voltage, wider frequency range, lower leakage, and a better output system.

The TYPE 1001-A Standard-Signal Generator covers carrier-frequencies from five kilocycles to fifty megacycles in eight logarithmic direct-reading ranges. It can be amplitude-modulated up to 80%

Figure 1. Panel view of the Standard-Signal Generator. Output cable and other accessories are shown on the top of the cabinet.

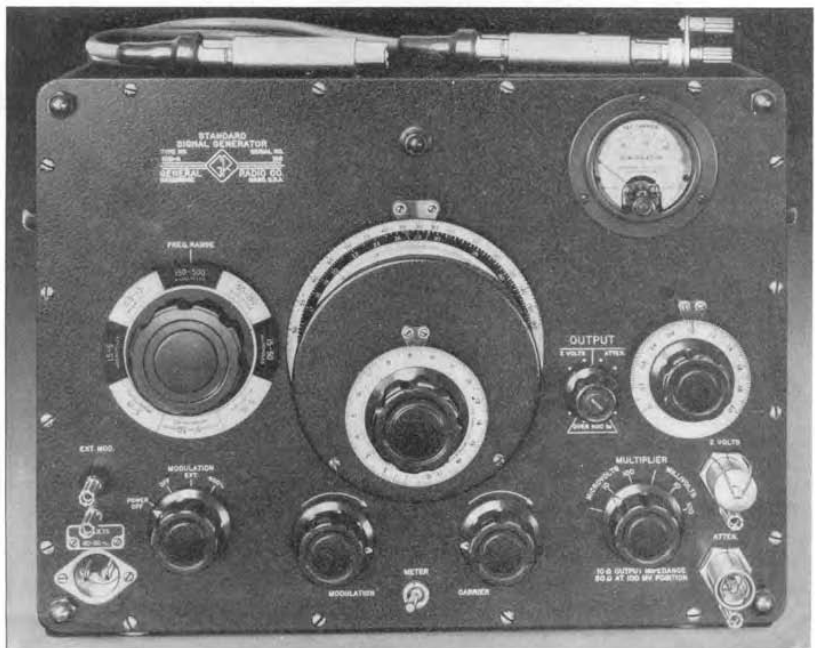

IET LABS, INC in the GenRad tradition
534 Main Street, Westbury, NY 11590

www.ietlabs.com
TEL: (516) 334-5959 • (800) 899-8438 • FAX: (516) 334-5988

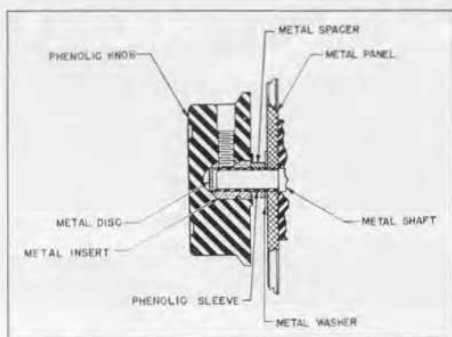

Figure 2. Method of shielding a shaft that projects through the panel. The metal insert of the knob, insulated from the shaft by a phenolic sleeve, is grounded to the panel through a metal washer.

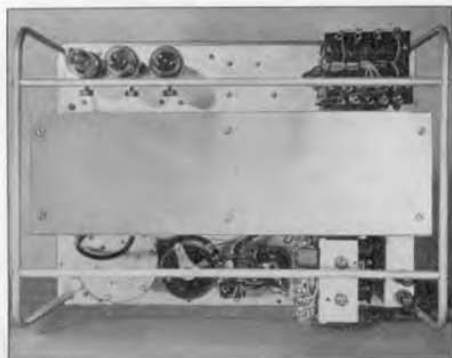
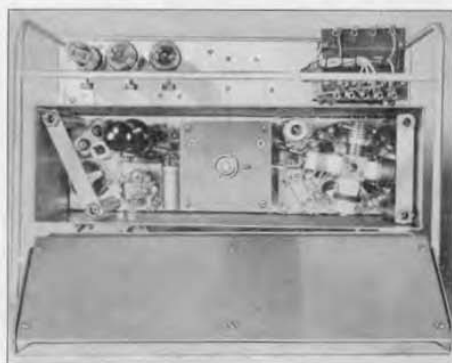

Figure 3. Interior view of the generator. The carrier-frequency compartment is in the center.

Figure 4. Rear view with cover removed from carrier-frequency compartment. The double cover is several hundred times as effective a shield as is a single one.



either at 400 cycles by the internal source or over the 20-15,000 cycle audio spectrum by an external source. The open-circuit output voltage at the attenuator jack can be adjusted from less than a tenth of a microvolt to 200 millivolts, with the smallest calibrated division at 0.1 microvolt. Two-volts output is available at a second jack. The generator can be operated from any 115- or 230-volt power line of 40- to 60-cycle frequency. Figure 1 is a panel view and Figure 3 is a rear view with cabinet removed.

Shielding

An outstanding feature of the generator is its freedom from leakage and stray fields. This has been achieved by enclosing all carrier-frequency circuits in a completely shielded compartment, which eliminates induced circulating currents and ground-return currents in the front panel. All leads entering the compartment are well filtered by resistance-capacitance networks using through-type capacitors. The all-metal cabinet and the compartment within it provide a very effective double-shield system.

Shafts extending through the panel from the carrier-frequency compartment, whether made of metal or of dielectric material, are a potential source of leakage. Metal shafts act as antennas and dielectric shafts behave as waveguides. Grounding the shafts at the front panel helps to reduce leakage, but for really effective shaft shielding it is necessary to enclose each shaft end that extends beyond the panel in a coaxial grounded shield. The shield around a metal shaft must be insulated from it. In the TYPE 1001-A Generator the metal inserts of the knobs are used as shields, as shown in Figure 2. They are



insulated from the metal shafts by phenolic sleeves and grounded by means of spring washers to the front panel.

The carrier-frequency compartment is a deep box with a flat cover. To avoid a multiplicity of screws for good contact, a rather unusual, but very effective, design was devised. The cover is made of two pieces with the inner and outer cover sections insulated from each other. The sides of each cover section make spring contact to the inner and outer walls respectively of the compartment, thus providing a shield within a shield. The double cover is several hundred times as effective a shield as is a single cover, yet it is easily removed, as shown in Figure 4, for access to all the tubes and most of the components in the compartment.

To facilitate testing and servicing, the sub-panel in the carrier-frequency compartment can be taken out relatively easily. All circuit components are then completely accessible as can be seen from Figure 5. A long connecting cable permits operation of the equipment in this "dissected" condition.

Oscillator

The basic circuit arrangement of the TYPE 1001-A Generator consists of a

Hartley-type carrier oscillator followed by a modulated amplifier, a carrier voltmeter, and an attenuator system. The schematic is given in Figure 7.

The Hartley-type oscillator has somewhat better high-frequency performance than that of the tuned-plate circuit used in the TYPE 605, and the coil structure is simpler. It uses a newly developed, insulated-rotor tuning capacitor, which has soldered plates, shaped for logarithmic frequency calibration, sturdy end plates, and ball bearings to avoid backlash.

The eight carrier-frequency oscillator coils are mounted on a turret-like disc, which places the active coil, as selected, close to the terminals of the tuning capacitor and of the 6C4-type miniature triode oscillator tube. Because coils are mounted on both sides of the disc, the turret is only four inches in diameter.

Considerable attention was devoted to the design of the coil-switching mechanism to obtain low contact-resistance which is essential for reliable operation at high frequencies. Contact is made between a three-tined blade and a cylindrical surface. This construction ensures at least a three-point contact. The contact springs are $\frac{3}{4}$ -inch long and are pre-loaded to obtain

Figure 5. Front view of the oscillator assembly. Connections to other circuits in the generator are made through the jack plate shown in the center. For servicing, the jack plate, which connects through the servicing cable shown at the right, can be detached and plugged into the generator chassis.

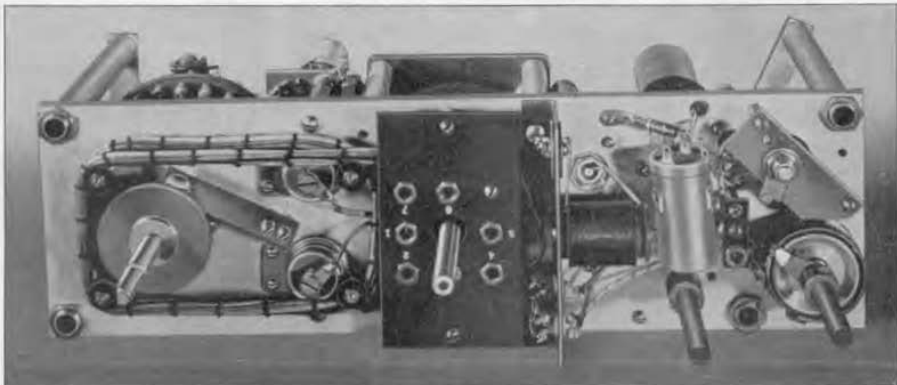

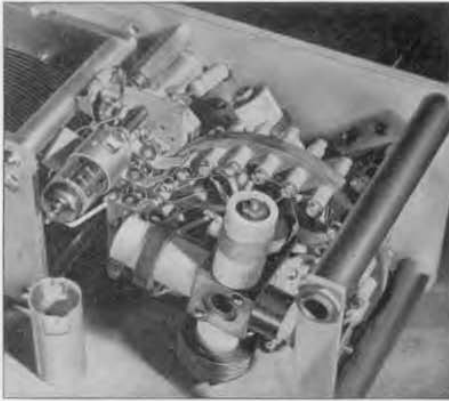

Figure 6. Close-up of the coil turret and switching mechanism. The switch blades are shown just to the right of the oscillator tube. Part of the tuning capacitor can be seen at the left.

pressure which is independent of minor misalignments. Figure 6 shows the coil turret and switch in detail.

Amplifier

The carrier oscillator is followed by a modulated, untuned, amplifier stage using a 6L6-type beam-power-amplifier tube. More output could be obtained by using a tuned amplifier, but only at a considerable increase in cost. Similarly, grid modulation, which gives good performance to about 80% modulation,

was chosen, rather than the inherently superior plate modulation, to avoid audio power amplification with its more costly power supply requirements. The small internal 400-cycle oscillator easily provides the voltage required for 80% modulation, and the external audio source need supply only 36 milliwatts.

Output System

The plate load of the modulated aperiodic amplifier is the output system of the signal generator; it consists of a vacuum-tube voltmeter, a voltage divider, and a six-step ladder-type resistance attenuator.

The d-c plate current of the output tube is about 40 milliamperes, and the carrier frequency component of plate current is limited to about 4 milliamperes to assure low distortion under modulation. The input impedance of the attenuator system is 50 ohms, and the maximum attenuator output is therefore 0.2 volt. Since voltage at this low level cannot be easily measured, resistance is connected in series with the attenuator system to increase the voltage at the carrier voltmeter to 1.6 volts, and also to make available a constant 2 volts output at another jack.

Figure 7. Elementary schematic circuit diagram of the Type 1001-A Standard-Signal Generator.

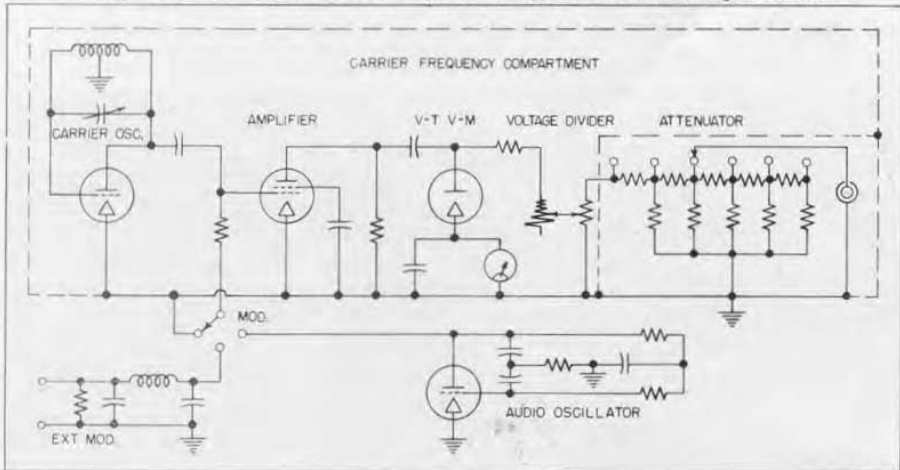



The output voltage is adjusted by means of the carrier-oscillator plate-supply control. The correct value is indicated by a reference line on the panel meter. A calibrated voltage divider provides continuous adjustment of output between the decade steps of the attenuator. The voltage-divider system was adopted in preference to the more obvious calibrated voltmeter method since it is difficult to obtain a reliable voltmeter calibration over a ten-to-one range at low voltage levels.

The voltage divider consists of two rheostats on the same shaft. They form a modified T-network and maintain to a constant value the effective load in the amplifier plate circuit. One of the rheostats is linear; the other is tapered; and both have non-inductive Ayrton-Perry windings. To maintain the accuracy of the system up to the highest output frequencies, the residual phase angle in the voltage divider is duplicated in the series resistor.

The ladder network contains a series and a shunt resistor at each attenuator step. The two resistors are wound on a common card of 10-mil mica. To assure correct attenuation at all frequencies, the phase angles of the two resistors in a series-shunt pair must be the same; various wire sizes and winding methods have been selected to assure the correct phase-angle match.

The mica cards are mounted in shielded segments of the cast attenuator housing (Figure 8), which contains the attenuator switch contacts. Complete shielding is necessary to reduce the attenuator input voltage to an accurate output of 0.1 microvolt. Over-all attenuation in this casting is one hundred thousand to one, and in the complete attenuator system it is sixteen million to one.



Figure 8. View of the casting that houses the MULTIPLIER network. One of the mica cards, with a series and a shunt element of the ladder network wound on it, is shown at the right.

The voltage appearing at the attenuator jack is indicated by the setting of the voltage-divider dial and of the attenuator MULTIPLIER. The output impedance is ten ohms for all but the 100 MILLIVOLTS setting of the MULTIPLIER where it is increased to 50 ohms. To increase the flexibility of the equipment, the output cable and terminations are supplied as separate items that may be used as demanded by the particular application. These accessories include a doubly shielded 50-ohm cable, a 50-ohm termination unit, and a 40-ohm series unit to provide, when need be, a 50-ohm output impedance at all MULTIPLIER settings. Additional accessories not supplied as standard equipment with the TYPE 1001-A Signal Generator include the TYPE 1000-P10 Test Loop and the TYPE 1000-P3 Voltage Divider, which provide two methods for testing loop-type radio receivers, and the TYPE 1000-P4 Standard Dummy Antenna for testing receivers designed for use with conventional antennas. These accessories are shown schematically in Figure 9. The generator output terminals as well as the accessories are all designed around the new



Figure 10. View of the Type 1000-P10 Test Loop, the Type 1000-P3 Voltage Divider, and the Type 1000-P4 Standard Dummy Antenna.

874-type coaxial system¹ where all connectors are identical, and plug-and-jack combinations are completely avoided.

¹W. R. Thurston, "A Radically New Coaxial Connector for the Laboratory," *General Radio Experimenter*, Vol. XXIII, No. 5, October, 1948.

Other Circuits

The remainder of the circuits used in the TYPE 1001-A Standard-Signal Generator are conventional and need no elaboration. The plate supply is regulated where necessary. Because a balanced diode circuit is used, the heater of the carrier vacuum-tube voltmeter tube does not require regulation. The 400-cycle audio oscillator is of the R-C type. The modulation voltmeter uses a pair of 1N34-type germanium crystals in a balanced, full-wave, voltmeter circuit.

Frequency Dial

There are three frequency calibrations on the main frequency dial, and they have been marked clearly to correspond with the ranges of the frequency selector switch. One of the frequency calibrations is used for the 5- to 15-kc, 50- to 150-kc, 0.5- to 1.5-Mc, and 5- to 15-Mc ranges. The dial calibration and the frequency range sectors have dark symbols against a light background for easy identification. A second frequency calibration is used for the 15- to 50-kc, 150- to 500-kc, and 1.5- to 5-Mc ranges; light symbols against a dark background are used here to dis-

Figure 9. Schematics of the output accessories supplied and of other accessories available. Various combinations of these elements can be used. For a review of the output characteristics of signal generators under various conditions of termination, see Arnold Peterson, "Output Systems of Signal Generators," *General Radio Experimenter*, Vol. XXI, No. 1, June, 1946.

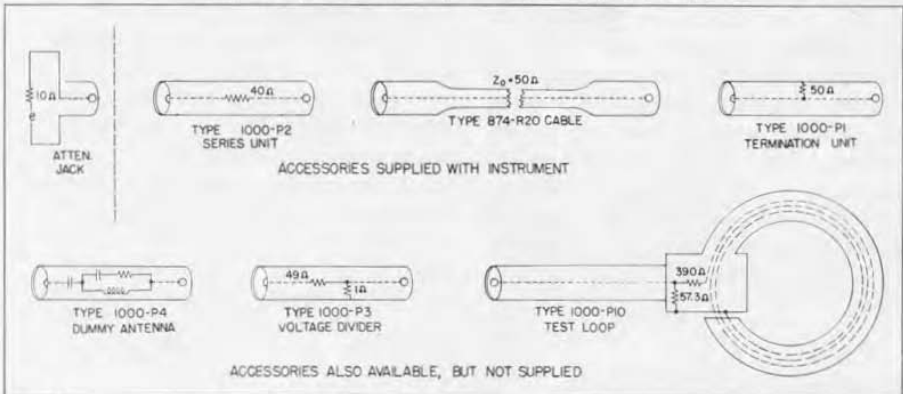



tinguish at a glance from the other frequency ranges. The highest frequency range (15 to 50 Mc) does not cover the full 180° rotation of the dial; it is identified at both the frequency dial calibration and the selector switch by a pair of parallel lines etched between the numerals.

The gear-drive mechanism is identical with that of the General Radio TYPE 908 Dial. About seven and a half turns of the vernier dial rotate the main dial over its total range. Since the calibrations for all but the 15- to 50-Mc range are logarithmic, the vernier dial indi-

cates directly in per cent frequency change for small frequency increments. Each division of the vernier dial corresponds to a 0.1% change in frequency for all frequencies below 15 Mc.

Cabinet

The instrument is housed in an all-aluminum welded cabinet for light weight, low cost, good shielding, and pleasing appearance. A compartment is provided in the cabinet top for storing the output cable and the other standard accessories.

— A. G. BOUSQUET

SPECIFICATIONS

Carrier-Frequency Range: 5 kilocycles to 50 megacycles covered in eight direct-reading ranges as follows: 5 to 15 kc, 15 to 50 kc, 50 to 150 kc, 150 to 500 kc, 0.5 to 1.5 Mc, 1.5 to 5 Mc, 5 to 15 Mc, and 15 to 50 Mc.

Frequency Calibration: Logarithmic up to 15 Mc, departing slightly from the logarithmic scale at higher frequencies. Accuracy, $\pm 1\%$.

Incremental-Frequency Dial: Frequency increment is 0.1% per dial division, at frequencies up to 15 Mc.

Frequency Stability: Warm-up drift is of the order of 0.25% in 24 hours. Half the maximum drift is reached in 1½ hours; 95% of maximum in four hours. Carrier shift with 80% modulation is 20 parts per million, or less.

Output Voltage Range: Open-circuit output voltage at the attenuator jack is continuously adjustable from 0.1 microvolt to 200 millivolts. With output cable terminated at both ends, output voltage is continuously adjustable from 0.05 microvolt to 100 millivolts. Open-circuit output voltage at the 2 volts panel jack is measured directly by the output meter and is 2 volts if the meter is set to the reference mark. This voltage is available up to at least 15 Mc.

Output Impedance:* Output impedance at the attenuator jack is 10 ohms (50 ohms when the series unit is used) except for the highest output position of the attenuator, where it is 50 ohms.

Output impedance at the end of the terminated cable is 25 ohms. Output impedance at the 2 volts panel jack is about 300 ohms.

An output impedance of one ohm (with output voltage reduced 100:1) can be obtained with the TYPE 1000-P3 Voltage Divider, a standard (IRE) test impedance with the TYPE 1000-P4 Dummy Antenna, and a known in-

duction field with the TYPE 1000-P10 Test Loop (see price list below).

Accuracy of Output Voltages: At frequencies below 10 Mc, when the output dial is set at about full scale or at about one-tenth full scale, the output voltage is correctly indicated to $\pm(6\% + 0.1 \mu\text{v})$. With the output dial set in the mid-scale region, the error may be greater or smaller by 4%. At frequencies above 10 Mc, when the output dial is set at about full scale, the output voltage is correctly indicated to an accuracy of $\pm(10\% + 0.3 \mu\text{v})$ and the error may be as much as 10% larger or smaller at other output dial settings.

The accuracy of the open-circuit output voltage at the 2 volts panel jack is $\pm 3\%$ up to 15 megacycles.

Amplitude Modulation: Adjustable from zero to 80%. Modulation percentage is indicated on the panel meter and is accurate within $\pm 10\%$ of the indicated value, with a possible additional error of 2% in modulation level.

The external modulation characteristic is flat within ± 1 decibel from 20 cycles to 15 kilocycles. To provide 80% modulation, the external audio oscillator must supply 12 volts into a 4000-ohm load (36 milliwatts).

Incidental Frequency Modulation: At 80% amplitude modulation, the incidental frequency modulation varies from about 10 to 100 parts per million over each carrier-frequency range except for the highest frequency range (15 to 50 Mc) where it may be three times as great. At lower modulation percentages, frequency modulation is approximately proportional to modulation percentage.

Carrier Distortion: Of the order of 5% on all except the lowest range, where it may increase rapidly, reaching 12% at 5 kc.

Envelope Distortion: About 6% at 80% amplitude modulation.

*See "Output Systems of Signal Generators," *General Radio Experimenter*, Volume XXI, Number 1, June, 1946.





Noise Level: Carrier noise level corresponds to about 0.1% modulation.

Leakage: Stray fields are substantially less than one microvolt per meter two feet from the generator.

Terminals: TYPE 874 Coaxial Terminals are provided for the attenuator output and for the constant 2-volt output.

Power Supply: 105 to 125 (or 210 to 250) volts, 40 to 60 cycles. Power input is approximately 65 watts at 115 volts.

Tubes: Supplied with the instrument.

- 1 — 6C4
- 1 — 6L6
- 1 — 6AL5
- 1 — 5Y3-GT
- 2 — OC3/VR105
- 1 — 6SN7-GT

Accessories Supplied: TYPE 874-R20 3-foot Coaxial Cable, TYPE 1000-P1 50-ohm Termina-

tion Unit, TYPE 1000-P2 40-ohm Series Unit, TYPE 874-Q2 Adaptor, TYPE 1000-215 Adjustment Tool, and a power cord.

Other Accessories Available: Not supplied but available on order are the TYPE 1000-P3 Voltage Divider, the TYPE 1000-P4 Standard Dummy Antenna, and the TYPE 1000-P10 Test Loop.

Mounting: The instrument is assembled on an aluminum panel finished in black crackle lacquer and mounted in an aluminum cabinet with a black wrinkle finish. The cabinet is provided with carrying handles. A recessed compartment is built into the top of the cabinet for storing the accessories.

Dimensions: (Height) $14\frac{3}{8}$ × (width) $20\frac{1}{4}$ × (depth) $10\frac{1}{8}$ inches over-all.

Net Weight: 52 pounds.

Type		Code Word	Price
1001-A	Standard-Signal Generator	ARGUS	\$595.00
1000-P3	100:1 Voltage Divider	ARMOR	15.00
1000-P4	Standard Dummy Antenna	ARROW	15.00
1000-P10	Test Loop	ARRAY	30.00

Licensed under patents of the Radio Corporation of America and under U. S. Patent No. 2,125,816.

MISCELLANY

RECENT VISITORS to our plant and laboratories include Mr. H. N. Hansen, Philips Telecommunication Industries, Hilversum; Mr. C. R. Krishnamurtky, Engineer, All-India Radio, New Delhi,

India; Mr. William Buys, Laboratory of Physics, University of Ghent, Belgium; and Mr. J. Bell, Chief Research Engineer, Muirhead and Co., Ltd., Beckenham, Kent, England.

THE General Radio EXPERIMENTER is mailed without charge each month to engineers, scientists, technicians, and others interested in communication-frequency measurement and control problems. When sending requests for subscriptions and address-change notices, please supply the following information: name, company address, type of business company is engaged in, and title or position of individual.

GENERAL RADIO COMPANY

275 MASSACHUSETTS AVENUE

CAMBRIDGE 39

MASSACHUSETTS

TELEPHONE: TR owbridge 6-4400

BRANCH ENGINEERING OFFICES

NEW YORK 6, NEW YORK
90 WEST STREET
TEL.—WOrth 2-5837

LOS ANGELES 38, CALIFORNIA
1000 NORTH SEWARD STREET
TEL.—Hollywood 9-6201

CHICAGO 5, ILLINOIS
920 SOUTH MICHIGAN AVENUE
TEL.—WAbash 2-3820

PRINTED
IN
U.S.A.

